



TECHNICAL SHEET

PERFORMANCE AND DIMENSIONS

Main features

Double pantograph geometric platform, with the widest outreach without limiting devices in its category. Electrically isolated up to 46kV, it allows it to work safely on or near high voltage lines. With its 27 meters of working height, its three areas of stabilization, the automatic leveling of the stabilizers, is able to operate at its best in any condition.

Max. working height	26,6 m
Max. outreach with 180 kg	13,3 m
Platform height	23,6 m
Max. load in basket	180 kg
Basket dimensions	0,6 x 0,6 x 1,1 m
Basket rotation	+90°
Turret rotation	+/- 200° (400° continuous)
Total weight	4680 Kg

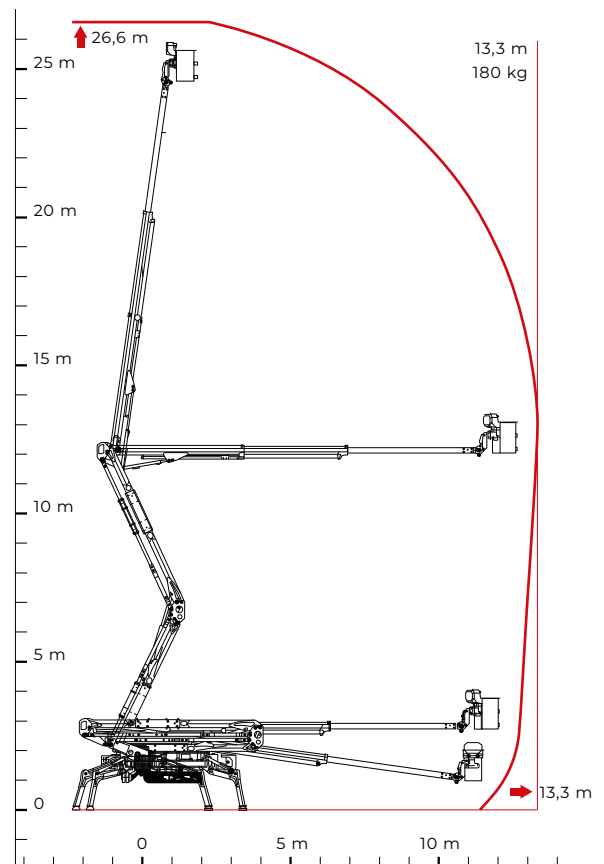

C.M.C. s.r.l.
Via Bitritto, 119 - 70124 Bari - Italy
Tel. +39 080 532 66 06
cmclift.com - info@cmclift.com



